

Fissaggio a muro
Fixing at the wall

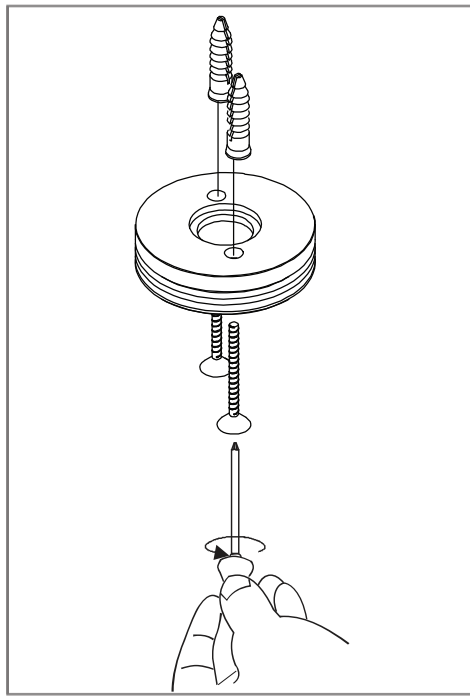

Fissaggio dei tasselli
Dowels fastening

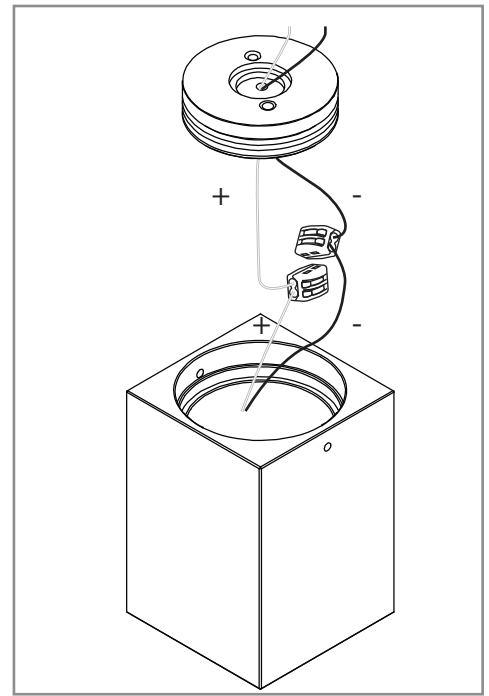

Cablare l'articolo
Wire the article

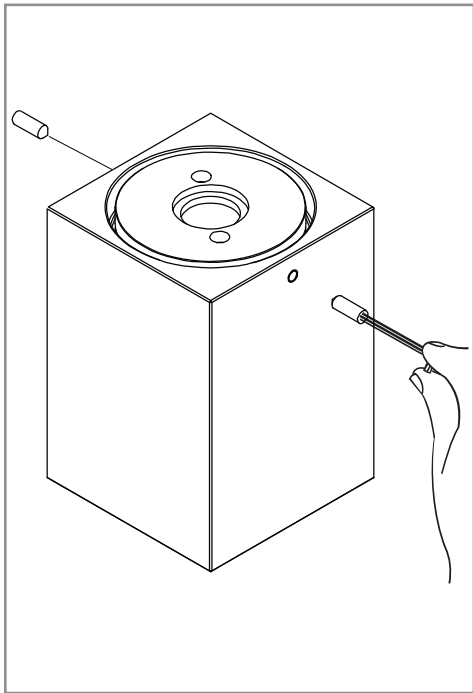

Avvitare il grano e fissare l'articolo alla staffa
Screw the screw and fix the article to the bracket

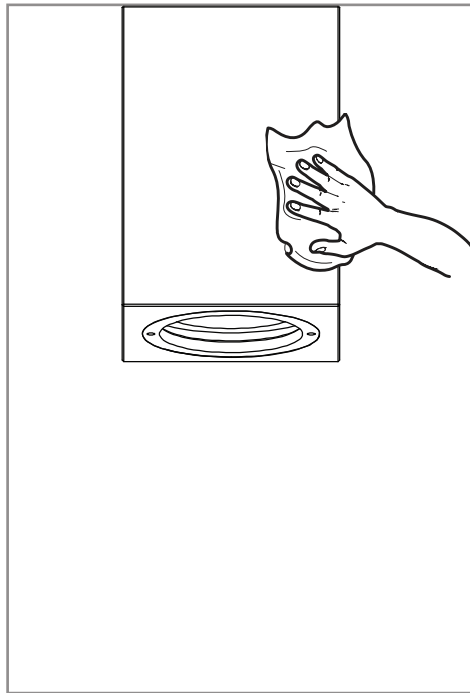

Installation kits

AL1450-IP
Alimentatore 14W 500mA

AL1435-IP
Alimentatore 14W 350mA



Edge Plafoniera

CE IP55 LED Kg 0,82

Code

325

Nr. 1 Led 5W

Light color

W 3000° K 483 Lumen CRI85

Light beam

00 Diffused Light

Finishing

Electrification

1x5W LED 500mA*

Plafoniera cubica da esterno con led di potenza 5W e 12W, fascio di luce verso il basso.

Outdoor cubic ceiling-lamp with 5W and 12W power LED, beam down.

*Alimentatore non incluso
Driver not included

AVVERTENZE:

L'installazione e la manutenzione vanno effettuate ad apparecchio spento. Tutte le operazioni devono essere effettuate da un tecnico specializzato. Modifiche o manomissioni del prodotto possono rendere l'apparecchio pericoloso.

La sicurezza e la funzionalità dell'apparecchio è garantita solo con il corretto rispetto delle istruzioni di montaggio/sicurezza. E' pertanto necessario conservarle.

L'apparecchio può raggiungere temperature elevate durante l'esercizio e pertanto occorre evitare il contatto con persone, animali o cose.

Effettuare la pulizia dell'articolo con un panno asciutto evitando l'uso di solventi o abrasivi. Evitare di spargere liquidi sulle parti elettriche.

La ditta CLM Srl declina ogni responsabilità per i danni causati da un proprio prodotto montato in modo non conforme alle istruzioni.

INDICE MARCATURE:

 Divieto di smaltimento dell'apparecchio o di una qualsiasi parte, presso la spazzatura domestica

 Apparecchio idoneo per sola installazione interna

 Europee EN 605981

 CLASSE I
Apparecchi con parti metalliche costantemente collegate al circuito di terra

 CLASSE II
Apparecchi con parti in tensione isolate tra loro e verso l'esterno con un doppio isolamento e senza dispositivi di massa a terra

 CLASSE III
Apparecchi alimentati con tensione di sicurezza inferiore ai 50V

 Apparecchi idonei per essere montati su superfici normalmente infiammabili

 Apparecchio idoneo per essere inserito nei mobili

IP20 Grado di protezione offerta dall'apparecchio contro la penetrazione di corpi Solidi (1° cifra) e Liquidi (2° cifra)

 Apparecchio con tecnologia LED

 Apparecchio con tecnologia LED e cambio del colore

 Dimensione del foro da praticare

 Diametro del foro da praticare

 Peso lordo del prodotto in Kg

WARNING:

Installation and maintenance must be done when full power is switched off. All operations should be performed by a specialized technician. Modifications or handling of the product may be dangerous.

The safety and the functioning of the equipment is guaranteed only by the observing of safety/mounting instructions. Please keep it for future uses.

The unit can reach high temperatures during operation and therefore any kind of physical contact must be avoided.

Clean the equipment by the using of a dry cloth, avoiding any abrasives or solvents. Please do not throw liquid on the electrical components.

The company CLM Srl assumes no responsibility for damages caused by a product installed not in accordance to instructions.

MARKING INDEX:

 The equipment or any part of it must not be thrown in the domestic garbage

 Equipment suitable for indoor installation only

 Compliant with EN 605981

 CLASS I
Equipment with metal parts constantly connected to the earth circuit

 CLASS II
Equipment with live parts insulated from one other and from outside with double insulation and without earthing devices DALI

 CLASS III
Equipment powered with safety voltage lower than 50V

 Equipmentsuitable to be fitted on normally inflammable surface

 Equipment suitable for installation in furnitures

IP20 Protection the equipment is equipped against the entry of solid bodies (1° number) and liquids (2° number)

 Equipment with LED technology

 Equipment with LED technology and colour changing

 Hole dimension

 Hole diameter

 Gross weight of product in Kg