

BEAM MASTER TRACK 35

Design Marc Sadler

Registered Design



SU RICHIESTA
ON REQUEST

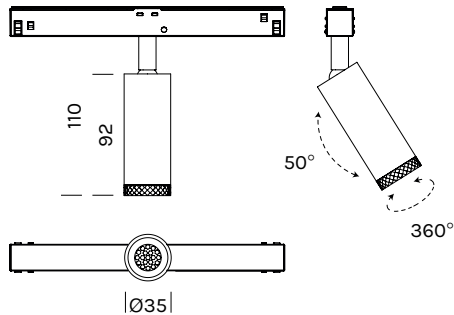
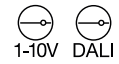

unità - unit = mm

Dati tecnici - Datasheet

Sorgente luminosa - Light Source	LED
Potenza - Power	1x 5,4W MAX
Alimentazione - Supply current	48Vdc
Lumen sorgente - Source lumens	2700°K= 534lm 3000°K= 557lm 4000°K= 627lm
Classe di isolamento - Safety class	III
IP	IP20
Classe energetica - Energy class	A / A+ / A++
Indice di resa cromatica - Colour rendering index	CRI97
Ottica - Optics	15° - 36°
Driver	escluso - excluded
Binario - Track	MAGNETIC TRACK 48V

Composizione codice - Code composition

example 1234W00-AA

Monocolore (ghiera inclusa) - Single color (ring included)

articolo item	temperatura colore colour temperature	°ottica °optic	finitura finish
4326	M 2700 °K	15 36	-BI Bianco opaco - RAL 9003 Matt white
	W 3000 °K		-BV Brunito verniciato Painted burnished
	N 4000 °K		-NE Nero opaco - RAL 9005 Matt black
			-OR Oro ricco Rich gold
			-RR Rame rosa Pink Copper
			-TI Titanio Titanium

BEAM MASTER TRACK 35

Design Marc Sadler

Registered Design

Personalizzato - Customized

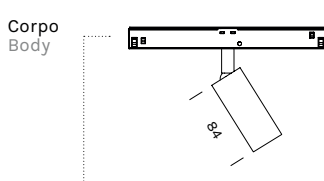
	articolo item	temperatura colore colour temperature	°ottica °optic	finitura finish
<p>Corpo Body</p> 	4321	M 2700 °K W 3000 °K N 4000 °K	15 36	-BI Bianco opaco - RAL 9003 Matt white -BV Brunito verniciato Painted burnished -NE Nero opaco - RAL 9005 Matt black -OR Oro ricco Rich gold -RR Rame rosa Pink Copper -TI Titanio Titanium
		Ghiera Ring		411

Alimentatori 48Vdc in tensione - Constant voltage drivers 48Vdc

articolo item	potenza power	dimensioni dimension	n° articoli alimentabili n° of items powerable
ELG7548	75W	180x63x35,5	1-12
ELG15048	150W	219x63x36	1-25

BEAM MASTER TRACK 35

Design Marc Sadler

Registered Design

Magnetic Track 48V

PLAFONE - CEILING

unità - unit = mm

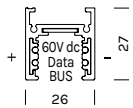

articolo item	finitura finish	lunghezza length
4020-1	-BI -NE	1000
4020-2	-BI -NE	2000
4020-3	-BI -NE	3000

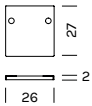

Accessori - Accessories

4020-T1	-BI -NE	Tappo di chiusura senza foro. 1 tappo fornito con viti End cap without hole. 1 end cap supplied with screws
---------	------------	----------------------------------------------------------------------------------------------------------------

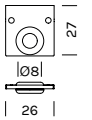

4020-T2	-BI -NE	Tappo di chiusura con foro. 1 tappo fornito con viti End cap with hole. 1 end cap supplied with screws
---------	------------	-----------------------------------------------------------------------------------------------------------

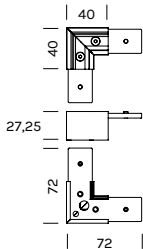

4020-C	-BI -NE	Cover per giunto a L Cover for L joint
--------	------------	-------------------------------------------

INCASSO - RECESSED

unità - unit = mm

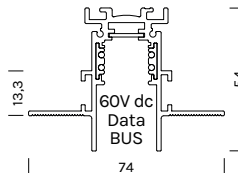

articolo item	finitura finish	lunghezza length
4021-1	-NE	1000
4021-2	-NE	2000
4021-3	-NE	3000

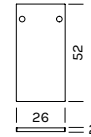

Accessori - Accessories

4021-T1	-NE	Tappo di chiusura senza foro. 1 tappo fornito con viti End cap without hole. 1 end cap supplied with screws
---------	-----	----------------------------------------------------------------------------------------------------------------

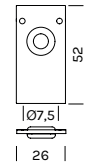

4021-T2	-NE	Tappo di chiusura con foro. 1 tappo fornito con viti End cap with hole. 1 end cap supplied with screws
---------	-----	-----------------------------------------------------------------------------------------------------------

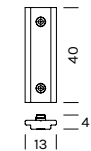

4021-G	-NE	Giunto lineare Linear joint
--------	-----	--------------------------------

MAGNETIC TRACK 48V CONNESSIONE

Testata di Alimentazione non polarizzata. Corrente e tensione nominale. Corpo in policarbonato. Contatti in lega di rame.

Non polarized end/feed. Rated current and voltage. Polycarbonate body. Copper alloy contacts

unità - unit = mm

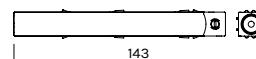

articolo item	finitura finish	
4020-A	-BI -NE	15A/60Vdc

MAGNETIC TRACK 48V GIUNTO

Giunto passante non polarizzato. Corrente e tensione nominale. Corpo in policarbonato. Contatti in lega di rame.

Non polarized jointing connector. Rated current and voltage. Polycarbonate body. Copper alloy contacts

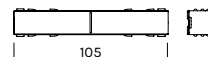

4020-GA	-BI -NE	15A/60Vdc
---------	------------	-----------

Giunto a L non polarizzato. Corrente e tensione nominale. Corpo in policarbonato. Contatti in lega di rame.

Non polarized L feed. Rated current and voltage. Polycarbonate body. Copper alloy contacts.

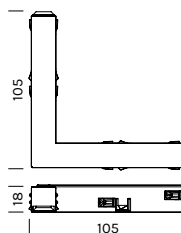

4020-GL	-BI -NE	15A/60Vdc
---------	------------	-----------