

INDOOR

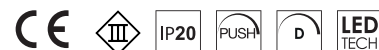

SOFFITTO / CEILING

POLY ESAGONO PL



Alluminio
Driver: escluso

Aluminum
Driver: excluded

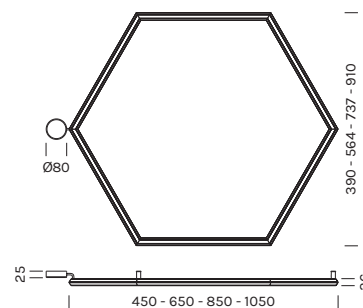

Monoemissione / Monoemission

9650	M 2700K	W 3000K	D 2700K/3300K
Potenza/ Power	1x 17,5W	1x 17,5W	1x 20W
Lumen	1x 2142 lm	1x 2142 lm	1x 1476 lm
CRI	97	97	90
Dimensione/ Dimension	Ø 450	Ø 450	Ø 450
Alimentazione/ Supply	24Vdc	24Vdc	24Vdc



Articolo Item	Temperatura Temperature	Finitura Finish	Dimmer Dimmer
9650	M	-BR	-
	W	-OR	-
9650	D	-BR	PUSH
		-OR	PUSH

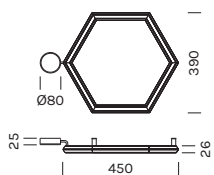

9651	M 2700K	W 3000K	D 2700K/3300K
Potenza/ Power	1x 26W	1x 26W	1x 31W
Lumen	1x 3213 lm	1x 3213 lm	1x 2214 lm
CRI	97	97	90
Dimensione/ Dimension	Ø 650	Ø 650	Ø 650
Alimentazione/ Supply	24Vdc	24Vdc	24Vdc





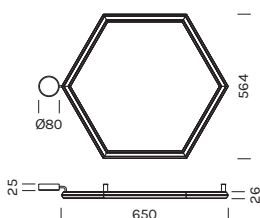

Articolo Item	Temperatura Temperature	Finitura Finish	Dimmer Dimmer
9651	M	-BR	-
	W	-OR	-
9651	D	-BR	PUSH
		-OR	PUSH

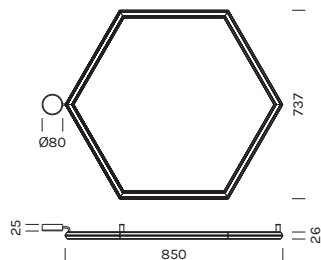

Il codice prodotto si compone mettendo uno dopo l'altro, da sinistra a destra, i dati nelle colonne gialle, es: 1111M12-AA
The product code is created by putting in sequence the data under the yellow columns from left to right, e.g:1111M12-AA





9652	M 2700K	W 3000K	D 2700K/3300K
Potenza/ Power	1x 34,5W	1x 34,5W	1x 41W
Lumen	1x 4284 lm	1x 4284 lm	1x 2952 lm
CRI	97	97	90
Dimensione/ Dimension	Ø 850	Ø 850	Ø 850
Alimentazione/ Supply	24Vdc	24Vdc	24Vdc

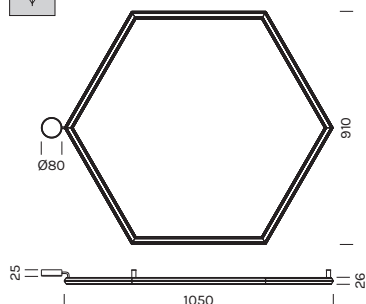

Articolo Item	Temperatura Temperature	Finitura Finish	Dimmer Dimmer
9652	M	-BR 	-
	W	-OR 	-
9652	D	-BR 	PUSH
		-OR 	PUSH

9657	M 2700K	W 3000K	D 2700K/3300K
Potenza/ Power	1x 43W	1x 43W	1x 51W
Lumen	1x 5355 lm	1x 5355 lm	1x 3690 lm
CRI	97	97	90
Dimensione/ Dimension	Ø 1050	Ø 1050	Ø 1050
Alimentazione/ Supply	24Vdc	24Vdc	24Vdc







Articolo Item	Temperatura Temperature	Finitura Finish	Dimmer Dimmer
9657	M	-BR 	-
	W	-OR 	-
9657	D	-BR 	PUSH
		-OR 	PUSH

Il codice prodotto si compone mettendo uno dopo l'altro, da sinistra a destra, i dati nelle colonne gialle, es: 1111M12-AA
The product code is created by putting in sequence the data under the yellow columns from left to right, e.g:1111M12-AA

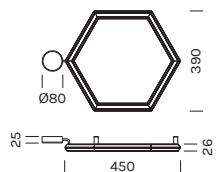
Biemissione / Biemission





9660	M 2700K	W 3000K	D 2700K/3300K
Potenza/ Power	2x 17,5W	2x 17,5W	2x 20W
Lumen	2x 2142 lm	2x 2142 lm	2x 1476 lm
CRI	97	97	90
Dimensione/ Dimension	Ø 450	Ø 450	Ø 450
Alimentazione/ Supply	24Vdc	24Vdc	24Vdc

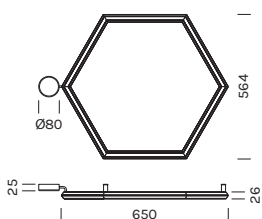

Articolo Item	Temperatura Temperature	Finitura Finish	Dimmer Dimmer
9660	M	-BR 	-
	W	-OR 	-
9660	D	-BR 	PUSH
		-OR 	PUSH





9661	M 2700K	W 3000K	D 2700K/3300K
Potenza/ Power	2x 26W	2x 26W	2x 31W
Lumen	2x 3213 lm	2x 3213 lm	2x 2214 lm
CRI	97	97	90
Dimensione/ Dimension	Ø 650	Ø 650	Ø 650
Alimentazione/ Supply	24Vdc	24Vdc	24Vdc

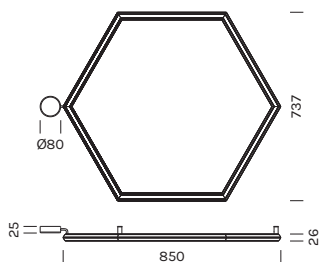

Articolo Item	Temperatura Temperature	Finitura Finish	Dimmer Dimmer
9661	M	-BR 	-
	W	-OR 	-
9661	D	-BR 	PUSH
		-OR 	PUSH





9662	M 2700K	W 3000K	D 2700K/3300K
Potenza/ Power	2x 34,5W	2x 34,5W	2x 41W
Lumen	2x 4284 lm	2x 4284 lm	2x 2952 lm
CRI	97	97	90
Dimensione/ Dimension	Ø 850	Ø 850	Ø 850
Alimentazione/ Supply	24Vdc	24Vdc	24Vdc

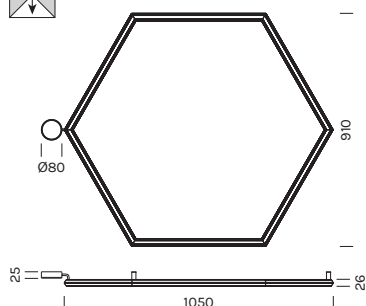

Articolo Item	Temperatura Temperature	Finitura Finish	Dimmer Dimmer
9662	M	-BR 	-
	W	-OR 	-
9662	D	-BR 	PUSH
		-OR 	PUSH

9667	M 2700K	W 3000K	D 2700K/3300K
Potenza/ Power	2x 43W	2x 43W	2x 51W
Lumen	2x 5355 lm	2x 5355 lm	2x 3690 lm
CRI	97	97	90
Dimensione/ Dimension	Ø 1050	Ø 1050	Ø 1050
Alimentazione/ Supply	24Vdc	24Vdc	24Vdc



Articolo Item	Temperatura Temperature	Finitura Finish	Dimmer Dimmer
9667	M	-BR 	-
	W	-OR 	-
9667	D	-BR 	PUSH
		-OR 	PUSH

Kit di Fissaggio / Fixing kit

	Articolo Item	Finitura Finish
Kit Fissaggio 3pz - H.30 Fixing kit 3 pieces - H30	181	-BR  -OR 



| 30 |

Kit Fissaggio 3pz - H.60 Fixing kit 3 pieces - H60	182	-BR  -OR 
---	------------	--



| 60 |

Kit Fissaggio 3pz - H.90 Fixing kit 3 pieces - H90	183	-BR  -OR 
---	------------	--



| 90 |

Alimentatori 24Vdc in tensione in remoto / Remote constant voltage drivers 24Vdc

Articolo Item	Potenza Power	IP	Dimensioni Dimensions	Dimmer
1A0150	30W MAX	IP20	160x58x18	-
1A0151	50W MAX	IP20	160x58x18	-
1A0152	75W MAX	IP20	160x58x18	-
1A0145	100W MAX	IP67	190x52x33	-
1A0153	150W MAX	IP20	240x60x49	-
1A0147	240W MAX	IP67	244x68x39	-

Centraline dimmerabili in remoto / Remote dimmable controllers

Articolo Item	Potenza Power	IP	Dimensioni Dimensions	Dimmer
1A0837	144W MAX	IP20	132x22x19	1-10V DALI PUSH
1A0838	288W MAX	IP20	150x38x25	0-10V 1-10V DALI PUSH
1A0172	240W MAX	IP20	57x43x19	CASAMBI PUSH

Controller 1 canale - DC

Controller 1 channel - DC

Centraline Dim to Warm (necessita di driver in 24Vdc) / Dim to Warm controller (requires 24V driver)

Articolo Item	Potenza Power	IP	Dimensioni Dimensions	Dimmer
1A0161	192W MAX	IP20	52x43x21	PUSH

Controller Dim to Warm 24V

Controller Dim to Warm 24V

Accessori / Accessories

Articolo Item	Dimmer
1A0162	TOUCH

Radiocomando Touch 1 canale solo per temperatura luce D (Dim to Warm).
Radio control Touch 1 channel, for D (Dim to Warm) only.

